

TECHNICAL DATA

ROLF BENZ 644



**ROLF
BENZ**

- Metal and wood internal framework
- The seat is built up in layers made of polyurethane foam, the top layer consists of a high-quality cold foam and is also covered with a polyester fleece covering.
- The backrest is built up in layers made of polyurethane foam, the top layer consists of a high-quality cold foam and is also covered with a polyester fleece covering.
- Body cover quilted with polyester fleece
- Steel bracket optionally: Smooth, powder-coated, matt
 - RAL 7022 Umbra grey
 - RAL 9017 Traffic black
 - Smooth steel, silver matt finish

Due to the way the furniture is designed, and its comfort level, some wrinkles and sitting pressure indentations are inevitable, even in top quality Rolf Benz upholstered furniture. All dimensions are approximate.

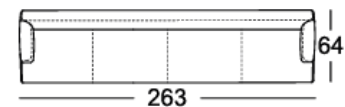
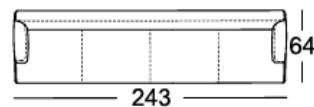
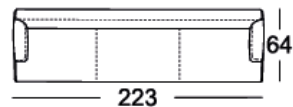
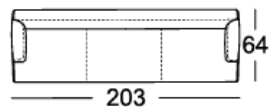
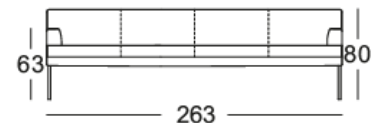
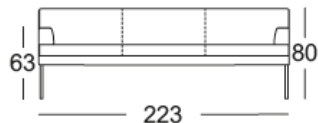
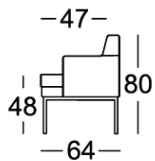
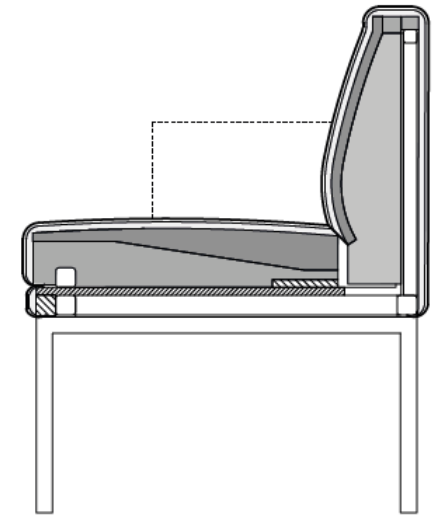

**ROLF
BENZ**