

TECHNICAL DATA

ROLF BENZ ELVA



**ROLF
BENZ**

- Wooden inner frame
- Coil spring unit
- Seat made of high-quality cold foam, built up in layers and coordinated in different thicknesses and hardnesses
- Backrest made of polyurethane foam
- Upper backrest made of cold foam
- Cover quilted underneath with non-woven polyester
- Seat height options 42 cm or 45 cm
- Cast metal leg, aluminium, powder-coated in matt finish, optionally:
 - RAL 9017 Traffic black
 - RAL 7044 Silk grey

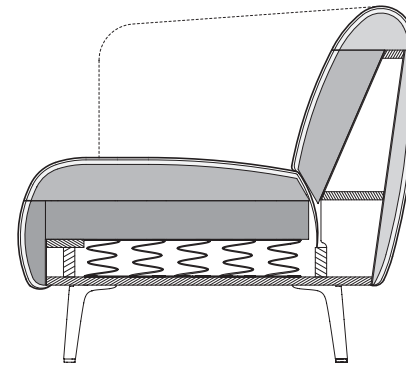

! High-quality, casual upholstery that forms waves / leaves indentations that are typical of the material. All measurements are approximate.

Seat heights available

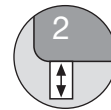

**ROLF
BENZ**

Sofa

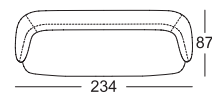
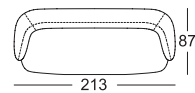
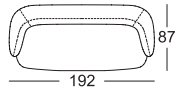

End sofa*

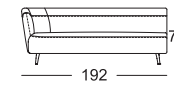
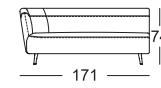
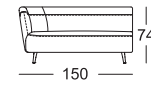
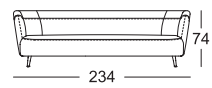
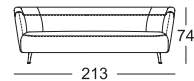
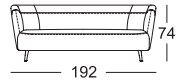
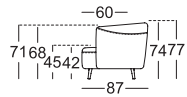
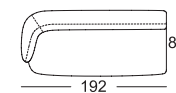
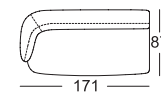
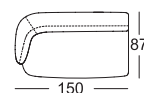

Corner end sofa*

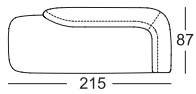

Sofa with footstool*

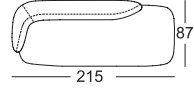
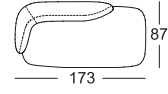

End longchair*

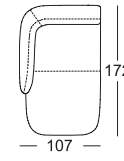
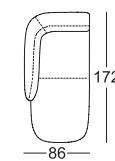

Footstool



Back cushion mat

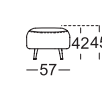
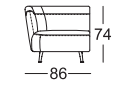
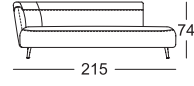
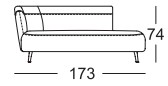
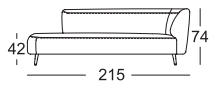
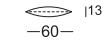

Armchair

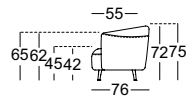

*These elements are only shown in the left version. They are also available in the right version.

Combination examples:

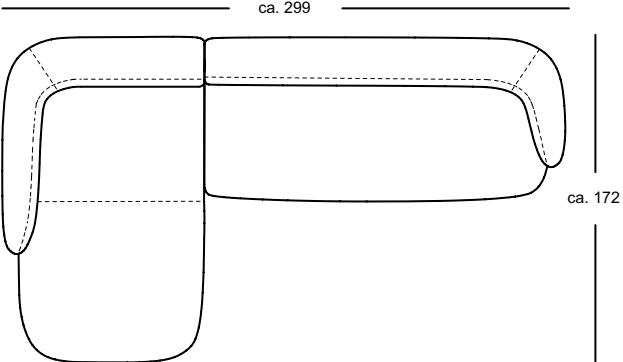

ALC 300/SB 84 le.
ASO 300/SB 168 ri.

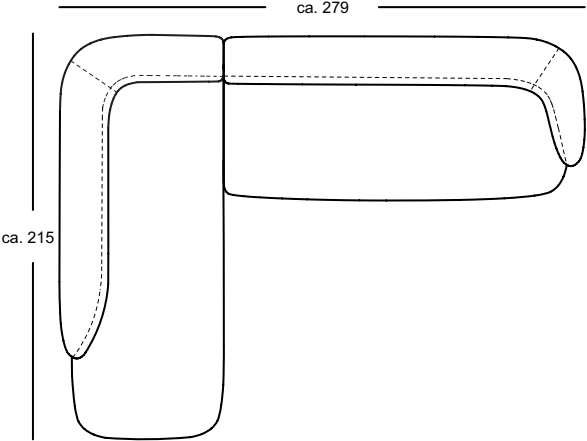

E-ASO-PSZ 300/SB 189 le.
ASO 300/SB 168 ri.